

Majrex[®] 200

System Guidelines
For Air Barrier
and Vapor Control
Installation

Introduction

These guidelines will outline the materials and process required to achieve a long-lasting a continuous air barrier (AB) and advanced moisture management assembly in commercial and residential construction, for the convenience of contractors, specifiers, and other construction professionals.

Diligence paid to sealing techniques, is crucial in creating a watertight and airtight enclosure for buildings that are required to deliver high performance.

These instructions do not replace any national, provincial, or local building codes. Install all products in accordance with manufacturer's specifications, local building codes, or (where applicable) specifications established by the licensed design professional.

Regional standard practices, environmental conditions, and codes may vary and supersede the procedures contained within. The responsibility for compliance is yours: the installer, inspector and owner(s).

Contents

Part 1 System Overview	4
1.1 Introduction	4
1.2 Components	4
1.3 Usage & Substrate Matrix	5
Part 2 Air Barrier Design Considerations	6
Part 3 Job Site Parameters	7
3.1 Preconstruction	7
3.2 Site Conditions	7
3.3 Storage	7
Part 4 Installation Requirements	8
4.1 Required Tools	8
4.2 Overlap Requirements	8
4.3 Sheet Installation Process	9
4.3.1 with Double-Sided Tape Twinet	9
4.3.2 with T50 Staples	10
4.4 Special Requirements for Blow-in Insulation	11
4.4.1 Insulation Containment	11
4.4.2 Injection holes	13
Part 5 Construction Details	14
5.1 Penetrations	14
5.1.1 Round Penetrations	14
5.1.2 Square Penetrations	15
5.1.3 Electrical Wires	16
5.2 Fenestrations	17
5.2.1 Interior Rough Opening Transitions	17
5.2.2 Window Air-Sealing	18
5.3 Airtight Details & Substrate Transitions	19
5.3.1 Substrate Transitions	19
5.3.2 Intersections with Exterior Wall	20
5.3.3 Interior Partition Wall Integration	21
SIGA Reliability	22
Product Information	23
Training	26

PART 1 System Overview

1.1 INTRODUCTION









This installation manual includes materials and installation procedures for SIGA Majrex® 200 air barrier and vapor control layer.

Majrex 200 with Hygrobrid® technology is a directional, moisture-variable, vapor control layer for interior roof, wall, and floor assemblies. The material is made from a modified PE /PA reinforced with PET fibres.

With the addition of compatible SIGA air-sealing components as outlined in these guidelines, the Majrex 200 system will also create a continuous interior air-barrier for high-performance construction. It is the responsibility of the design authority of record to confirm or adapt these guidelines to support project-specific parameters and local code compliance. For procedures and conditions beyond the scope of this document, or for assistance with modifying specific details, please consult your local licensed design professional or SIGA representative.

1.2 COMPONENTS

Use the SIGA products below to complete a resilient interior vapor control layer. Additional product data can be found at the end of these guidelines, or at siga.swiss.

	PRODUCT	DIMENSIONS	AREA
MEMBRANE PRODUCTS			
	Majrex® 200	59 in x 164 ft	804 sq ft
TAPE PRODUCTS			
	Twinet®	3/4 in x 164 ft	
	Rissan® 60	2.4 in x 82 ft	
	Rissan 100	3.9 in x 82 ft	
	Rissan 150	5.9 in x 82 ft	
	Fentrim® IS 20 75mm	2.9 in x 82 ft	
	Fentrim IS 20 100mm	3.9 in x 82 ft	
	Fentrim IS 20 150mm	5.9 in x 82 ft	
PRIMER			
	Dockskin® 100	2.2lbs	54 sq ft / bottle

PART 1 System Overview

1.3 USAGE & SUBSTRATE MATRIX

	Majrex 200	Twinet	Rissan 60	Rissan 100/150	Fentrim IS 20
RECOMMENDED USAGE					
Membrane					
Penetration Sealing					
Fenestrations (Interior Air-Sealing)					
Substrate Transitions					
Damage Repairs					
Membrane Overlaps					
Membrane Temporary Fixation					
SUBSTRATES WITH RECOMMENDED MINIMUM OVERLAP					
Plywood		3/4"	1"	1"	1"
OSB		3/4"	1"	1"	1"
Metal		3/4"	1"	1"	1"
Rigid Insulation EPS / XPS / PU		3/4"	1"	1"	1"
Concrete				2" <small>*Dockskin 100</small>	2"
Hard Plastics		3/4"	1/2"	1/2"	1/2"
Electric Cables			1/2"	1/2"	1/2"
Majrex 200	4"	3/4"	1"	1"	1"

PART 2 Air Barrier Design Considerations

Majrex 200 will support creation of a durable interior air-barrier wall assembly, in addition to performing as a robust vapor retarder.

Completing a whole-building air-tightness approach requires maintaining this continuous and sealed layer, as it transitions in, out, and around structural components, penetrations and interior finish. Proper detailing, construction sequencing, and material selection are essential to achieving this additional air-tight attribute.

When choosing the placement of Majrex 200 in your high-performance wall assembly, consider implementing a service cavity between membrane and interior finish. This design strategy can effectively manage penetrations from interior finish, isolate plumbing and electrical routing, and offer additional structural support for preceding layers.

To find out more about the unique *Hygrobrid Technology*[®] used by Majrex 200, please refer to the Technical bulletin “Functional Principle of SIGA Majrex 200” available on siga.swiss.

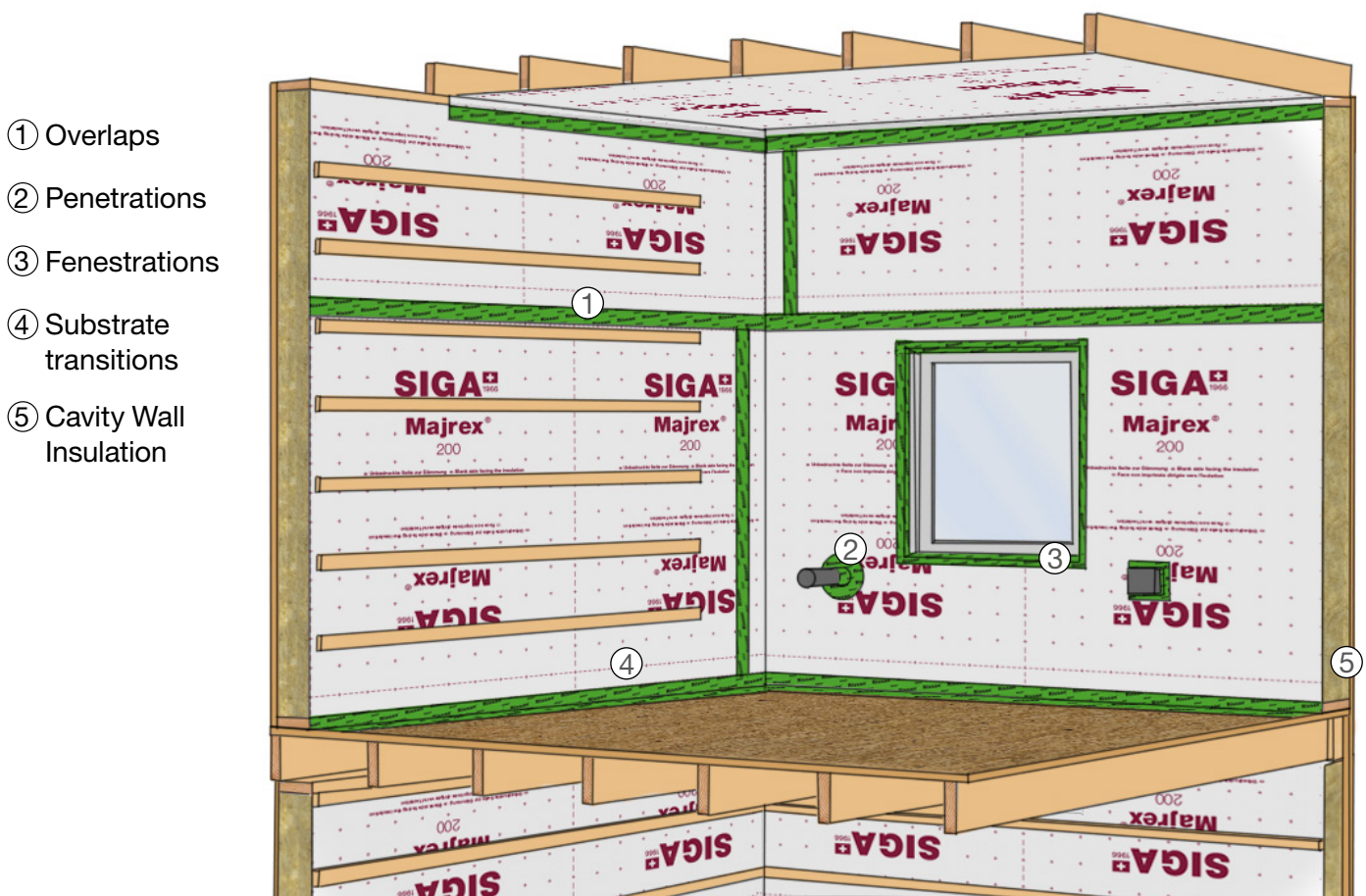

Figure 1

PART 3 Job Site Parameters

3.1 PRECONSTRUCTION

Air-barrier continuity requires collaboration between everyone involved in the building project. For best results, convene a preconstruction meeting with all parties relevant to building envelope construction before proceeding with the installation of the vapor retarder.

- Construct a project-specific mockup to manage the constructibility, compatibility, and sequencing of different materials and processes
- Full curing of all sealants and subsequent water intrusion and air-tightness testing is recommended
- Ensure that all building components e.g. windows, doors, penetrations, etc. are installed in accordance with the manufacturer's instructions.

3.2 SITE CONDITIONS

- Maximum UV-exposure of installed Majrex 200 is 30 days
- Cover membrane as soon as practical after installation
- Do not install in rain or inclement weather, or when substrate is damp or frost-covered
- Protect in-progress installations from wet weather
- Avoid accumulation of dirt and debris onto facer during installation
- Check and clean any unnecessary protrusions on the studs prior to installation

3.3 STORAGE

- Store Majrex 200 in original packaging in a cool, dry location
- Protect from UV exposure during storage
- No long-term storage limitations, when above conditions are maintained

PART 4 Installation Requirements

4.1 REQUIRED TOOLS

- Sharp razor knife
- Chalk-line or pencil
- Tape measure
- Hammertacker or other fastener device

4.2 OVERLAP REQUIREMENTS

- Minimum vertical and horizontal overlap is 4"
- Utilize factory-printed guide-marks for efficient installation
 - > Overlap and cutting alignment aid = 4" (100 mm) grid
 - > Tape overlap zone to align edge of Rissan 60 = 1.2" (30mm) line
 - > Overlap zone = 4" (100 mm) line
 - > Measuring aid = 39-3/8" (1000 mm) line

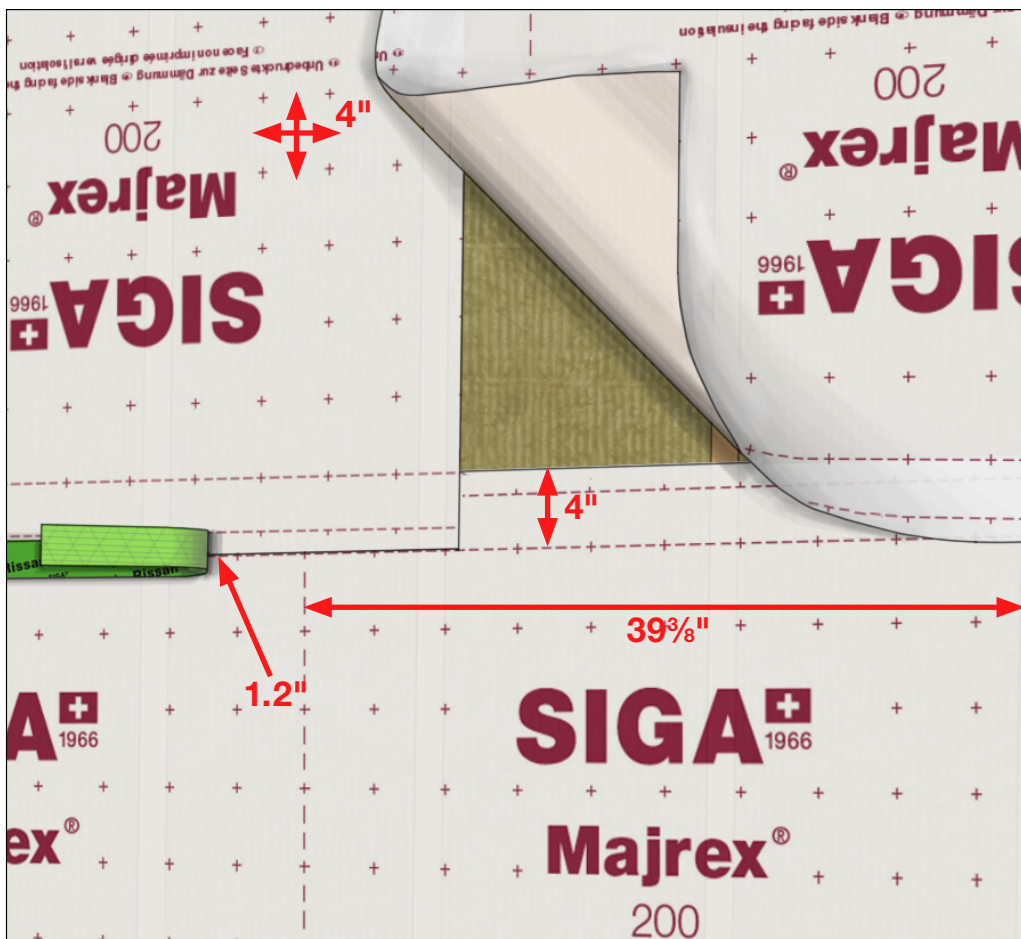

Figure 2



Attention: Due to the directional properties of Majrex 200 make sure the printing is facing the interior

PART 4 Installation Requirements

4.3 SHEET INSTALLATION PROCESS

4.3.1 with Double-Sided Tape Twinet

1. Install Twinet on studs

- Install Twinet on entire length of each horizontal and vertical stud while leaving the backing attached
- No double application necessary for stud packs

2. Establish level

- Cut through Twinet release liner at established level and peel back about half-way down the stud

3. Position upper half of membrane

- Start at upper corner and press on Majrex 200 while ensuring level
- Gradually work towards the side and install Majrex 200 wrinkle-free

4. Position lower half of membrane

- Carefully flap up lower half of membrane and hold up temporarily
- Gradually remove release liners starting from the middle while holding up the corners
- Work towards the corners while ensuring wrinkle-free application

5. Roll membrane onto studs

- Use a rubber roller or other pressure tool to activate the pressure sensitive acrylic adhesive
- Repeat on every stud

6. Tape membrane overlaps

- Install next course of Majrex 200 while ensuring a 4" horizontal and vertical overlap
- Use Rissan 60 to tape overlaps using the printed taping guide as a reference
- Roll on to activate the pressure sensitive acrylic glue

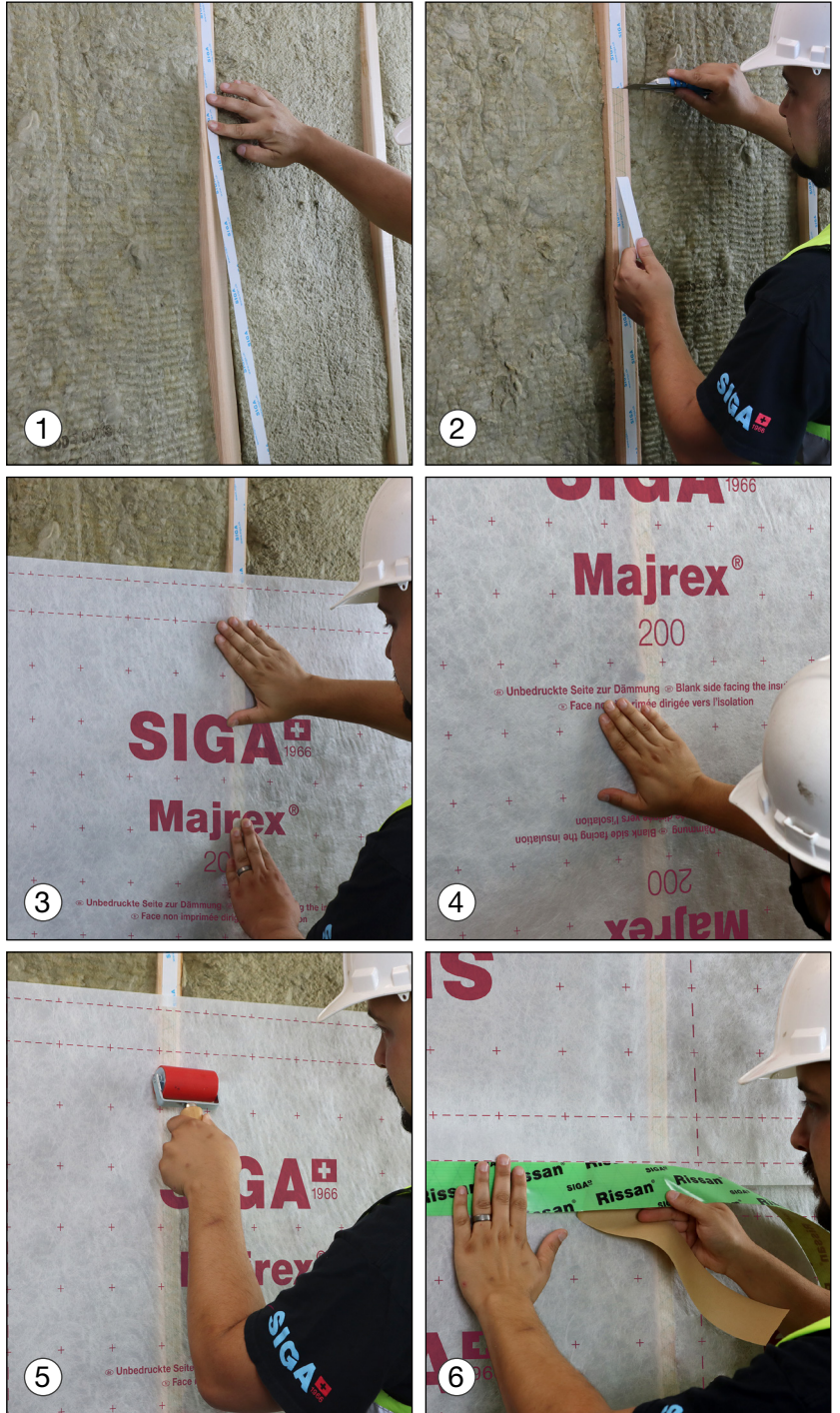

If you are relying on SIGA Majrex 200 as your main air barrier, use of SIGA Twinet provides superior air tightness due to the omittance of mechanical fastening

PART 4 Installation Requirements

4.3.2 with T50 Staples

1. Establish level

- Mark course height using a pencil or chalk line

2. Orient course

- Start upper corner at level mark and fasten using regular T50 staples
- Favor shorter manageable lengths (12'-15') for wrinkle free application

3. Position upper half of membrane

- Work towards the side while only fastening the membrane within the printed overlap zone
- Repeat for entire length of membrane section while ensuring level application

4. Position lower half of membrane

- Starting from the middle smooth out membrane and fasten along the stud
- Grab one corner and straighten while working towards the outside
- Staple about every 4" depending on insulation type

5. Install next course of membrane

- Install next membrane course while ensuring a 4" horizontal and vertical overlap
- Use factory-printed grid and overlap guides to simplify installation

6. Tape membrane overlaps

- Use Rissan 60 to tape overlaps using the printed taping guide as a reference
- Roll on to activate the pressure sensitive acrylic glue

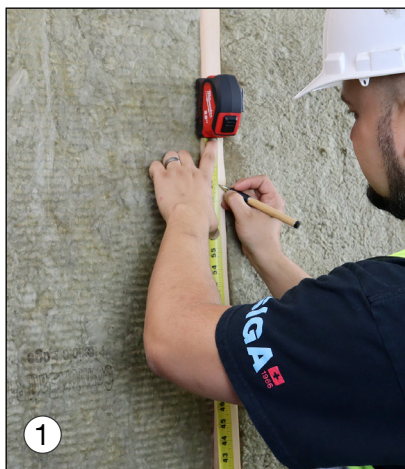

Install membrane slightly loose at junctions to accommodate expansion and contraction of the structure

PART 4 Installation Requirements

4.4 SPECIAL REQUIREMENTS FOR BLOW-IN INSULATION

There are various types of blow-in insulation products on the market ranging from cellulose to fiberglass and even mineral wool. Installation is generally done using a blow-in hose but setting pressures largely depend on desired R-value and type of installation. For high performance envelopes often a dense-pack installation is desired due to better settling behavior over time. This however means that large installation pressures may be experienced. In order to achieve a satisfactory install, SIGA recommends tighter stapling patterns and the use of counter battens to help minimize pillowing of the vapor control layer and reduce strain on the taped overlaps. The recommendations below may be evaluated on a case to case basis and be adapted to specific site conditions.

4.4.1 Insulation containment

- For stud / rafter spacings of less than 20":
 - > Install Majrex 200 horizontally, use Rissan 60 to tape overlaps
 - > Staple every 2" on every stud
 - > Install strapping at 16" O.C.

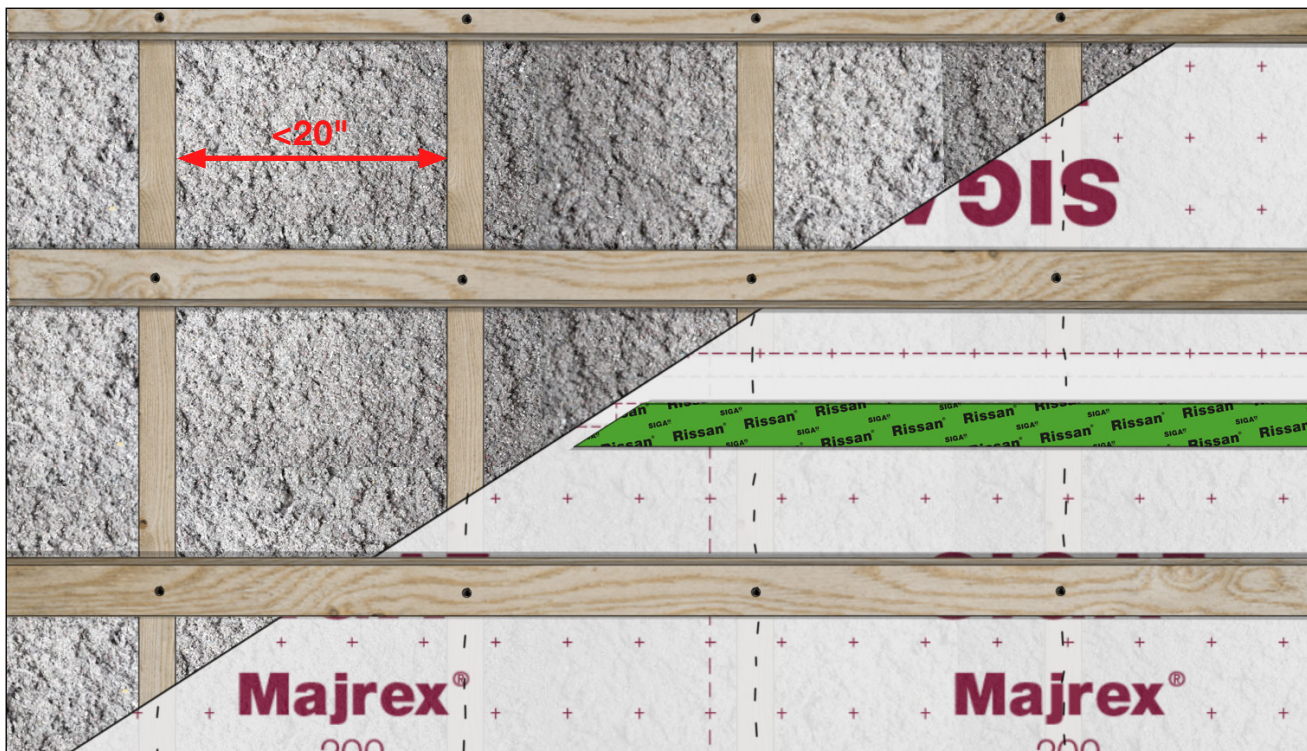

Install staples vertically along the stud for more resilient attachment with high blow in pressures. This prevents punctual strain from the mechanical fastener.

PART 4 Installation Requirements

- For stud / rafter spacings **wider than 20"** or under heavy-weight insulation loads:

Option A

- > Install Majrex 200 horizontally, use Rissan 100 to tape overlaps
- > Staple every 2" on every stud
- > Reinforce tape joints at the center of stud cavities with a perpendicular piece of Rissan
- > Install strapping at 16" O.C.

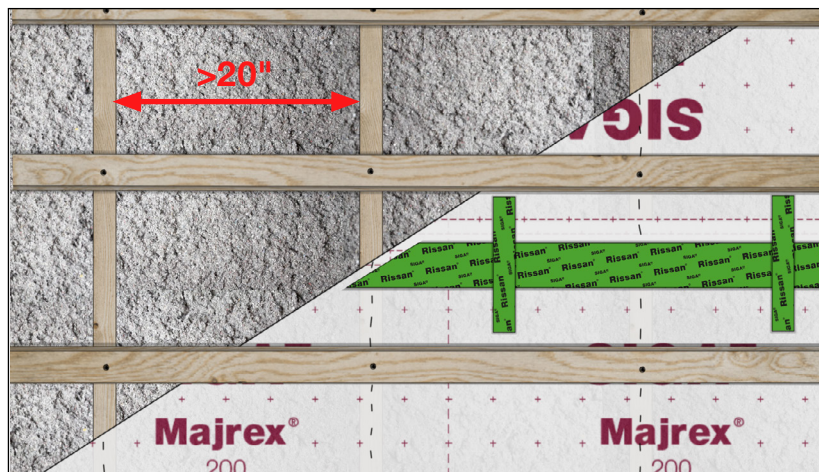

Option B

- > Install Majrex 200 vertically, use Rissan 60 to tape overlaps
- > Ensure membrane overlaps are crossing at a stud
- > Staple every 4" on every stud
- > Install strapping vertically on top of main studs



Did you know?

The use of strapping provides a service cavity, which is a great way to install electrical and plumbing without interfering with the vapor control layer. Damage by trades and later occupancy will be minimized. Even without the use of blow-in insulation this is a great way to achieve a high level of airtightness.

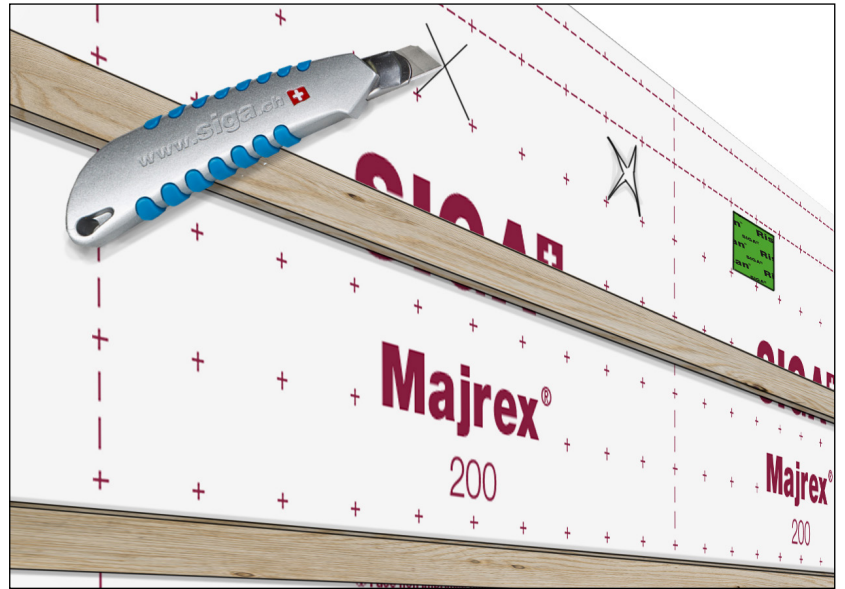

Figure 3

PART 4 Installation Requirements

4.4.2 Injection holes

- Always install blow-in insulation in accordance with manufacturer's instructions
- Make an x-cut to the size of the pipe nozzle centered at top of each cavity
- Cut pressure-release holes if necessary to adequately fill cavity due to airtightness of Majrex 200
- Use squares of Rissan 100 to patch holes after insulation has been installed



Some blow-in insulation products may be installed using proprietary containment netting. If these products are installed in accordance with the manufacturers instructions and represent the main means of containment, Majrex 200 may be installed in regular fashion after installation is complete.

PART 5 Construction Details

5.1 PENETRATIONS

5.1.1 Round Penetrations

1. Cut Majrex 200 cleanly around penetration
 - Recommended unsupported gap of 1/2" maximum
2. Create a gasket with short pieces of Rissan 60
 - Fold tape lengthwise
 - Apply to penetration, then to Majrex 200
 - Press on firmly
3. Repeat, overlapping each piece of tape to assemble a gasket

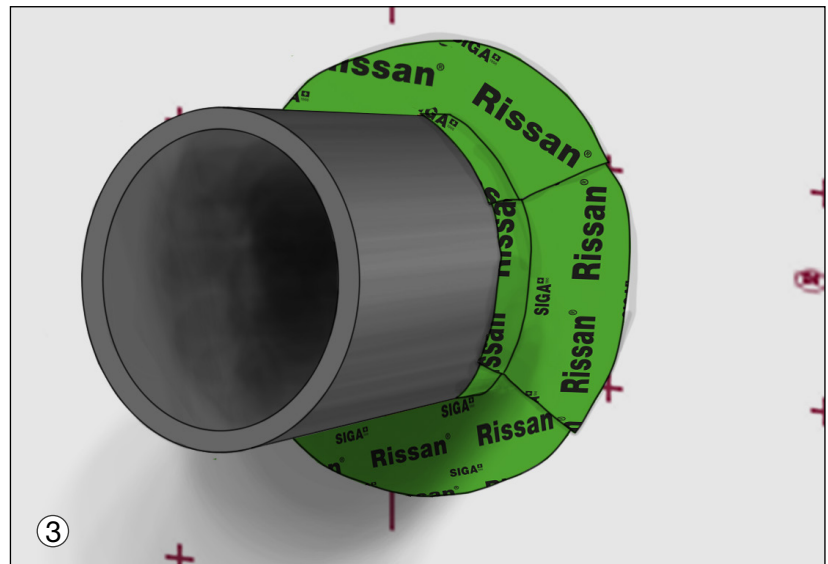
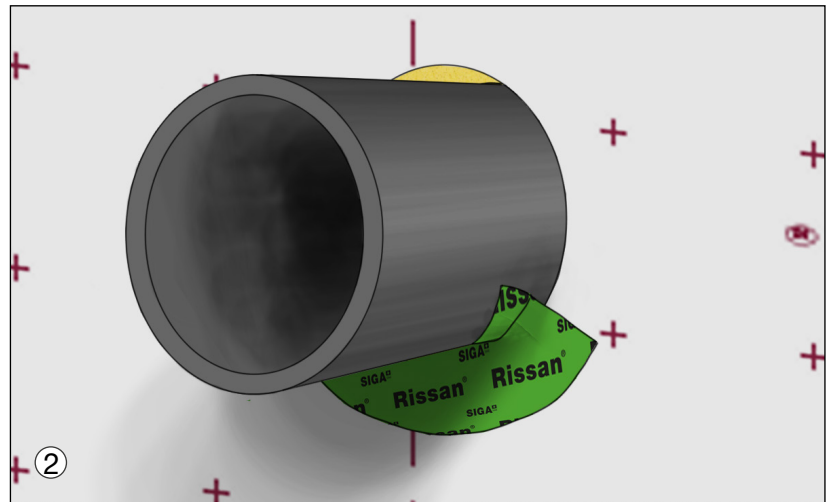
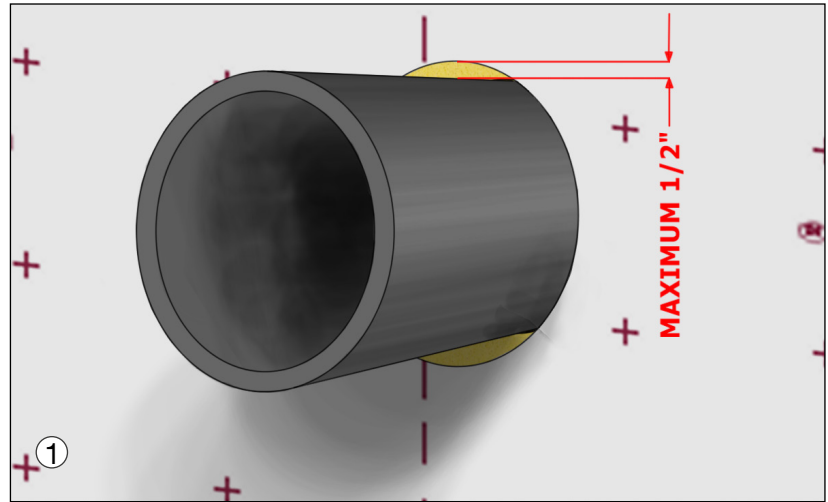

PART 5 Construction Details

5.1.2 Square Penetrations

1. Cut Majrex 200 cleanly around penetration
 - Recommended unsupported gap of $\frac{1}{2}$ " maximum
 - Cut piece of Rissan to extend 1" past left and right horizontal edge of penetration
 - Fold Rissan in half lengthwise and bond to penetration then to Majrex 200
 - Make 45° cuts at each end, from the inside corner outward
 - Press on firmly
2. Repeat for 2 vertical lengths of penetration
3. Repeat for horizontal top edge

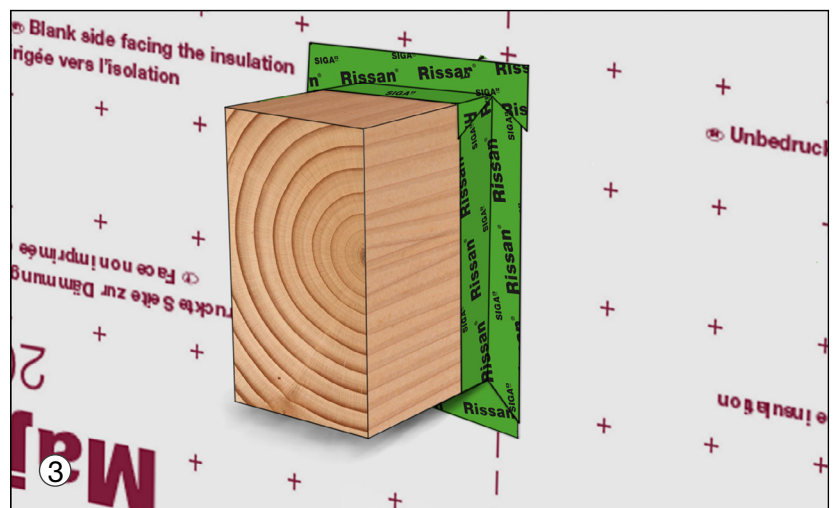
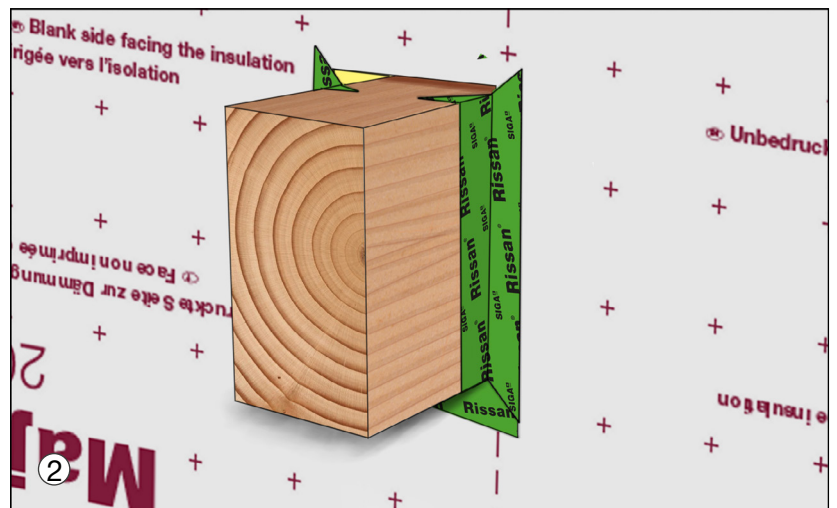
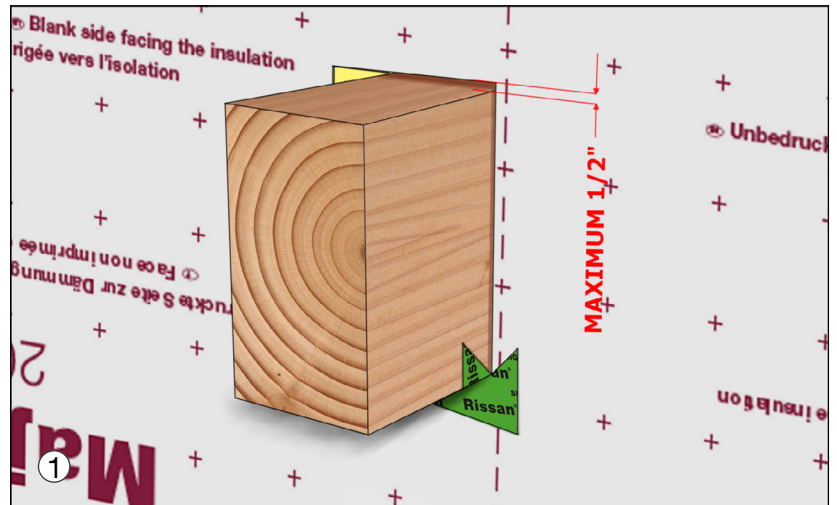

PART 5 Construction Details

5.1.3 Electrical Wires

1. Cut piece of Rissan 100 approx. 1.5" wider than each side of wire
 - Crease along split backing and remove one backing strip
 - Apply horizontally to Majrex 200, centered beneath wire
2. Cut another piece of Rissan 100 approx. 1" wider than each end of previous piece.
 - Crease along split backing, remove one backing strip and apply horizontally above wire
 - Remove remaining backing strips and bond adhesive surfaces together, encapsulating the wire
3. Fold unbonded ends down at 45° and bond to underside of flap

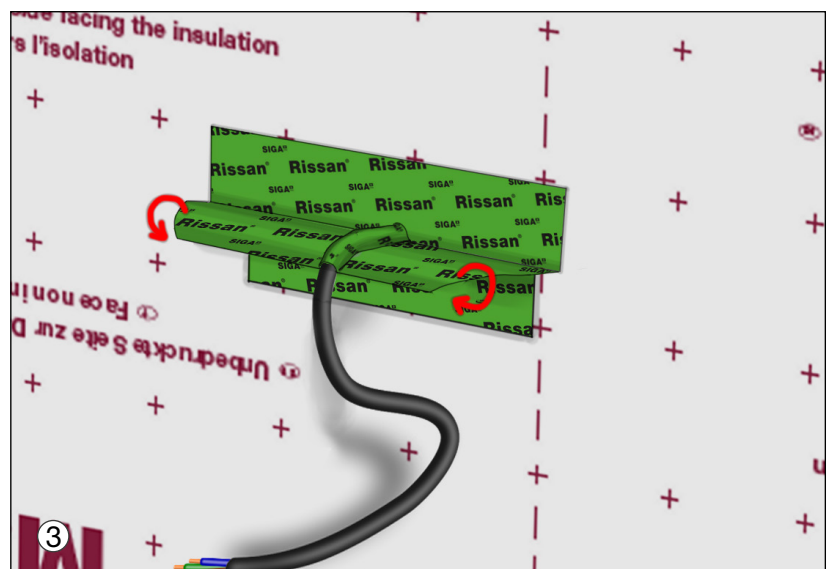
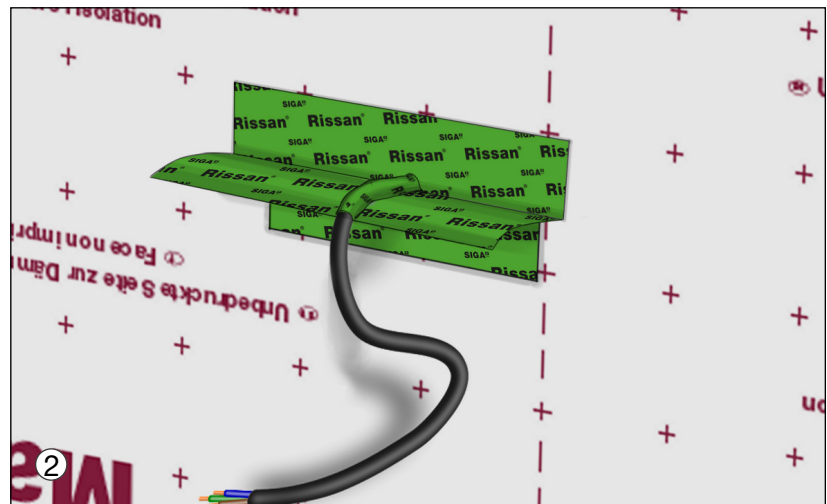
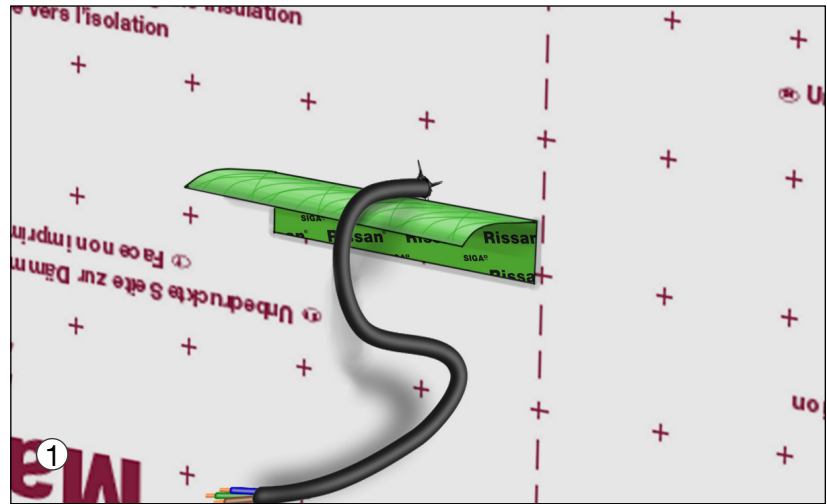

PART 5 Construction Details

5.2 FENESTRATIONS

5.2.1 Interior rough opening transitions

1. Mount Majrex 200 securely around perimeter of rough opening
 - Trim Majrex 200 flush with rough framing
 - Verify that the corners of the rough framing have been air-sealed. If not, use Rissan to tape each inside corner
2. Measure lengths of Rissan to extend 1" beyond each edge of the rough opening
 - Fold Rissan in half length-wise and apply lightly to Majrex 200—DO NOT PRESS
 - Make 45° cuts at each end, from the inside corner outward
 - Fold the length of Rissan into the opening and fold the shorter cut angle into the corner
3. Repeat to seal the entire perimeter of the opening

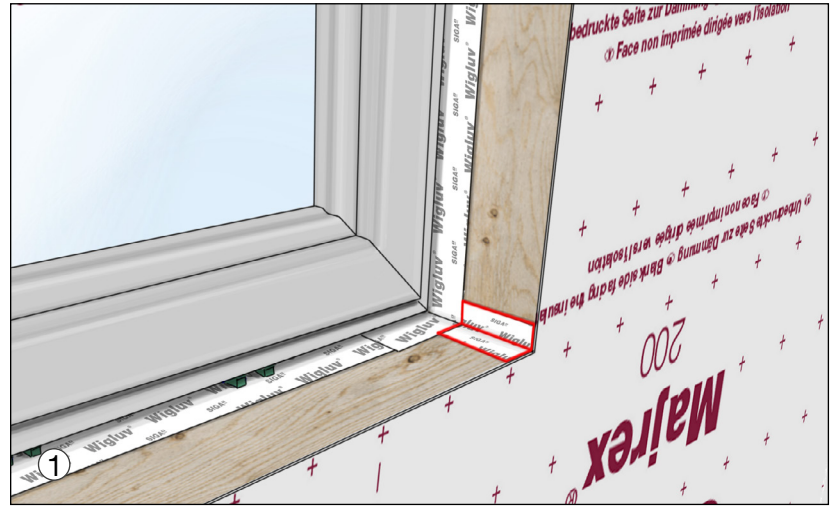

PART 5 Construction Details

5.2.2 Window air sealing

1. Cut a 3" piece of Fentrim IS 20 and make a cross cut at the narrow 5/8" prefolded section
 - Crease the center of the wide section and bond the 2 crosscut parts together forming a corner
 - Bond to both window and rough opening—repeat for each corner
2. Cut full length piece for window jamb
 - Bond first to window then bridge to rough opening
 - Maintain constant 5/8" contact with window frame
 - Repeat for jamb, sill and head
 - Press on firmly

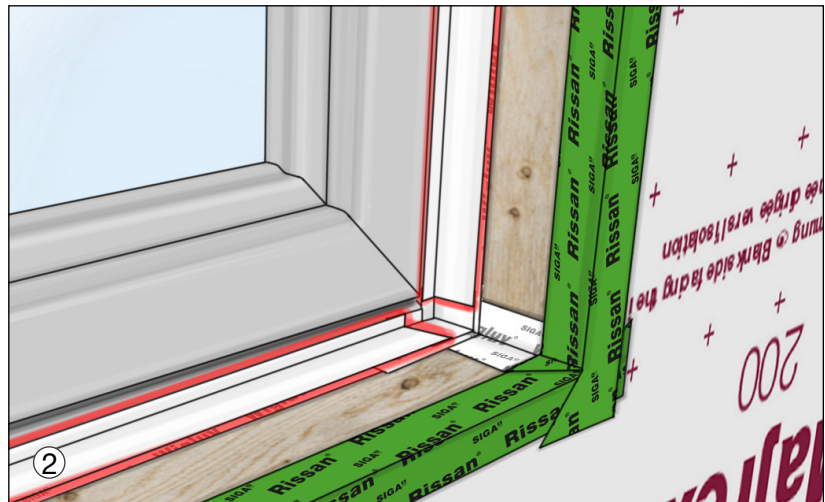
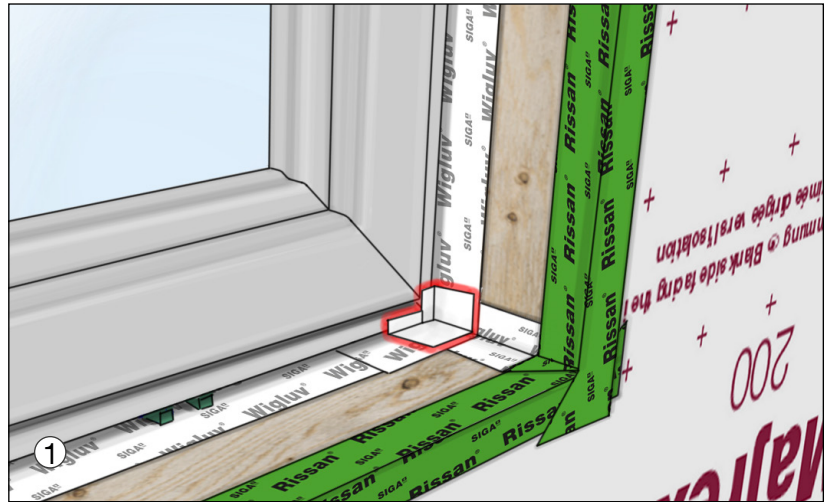

Download the Ultimate Guide to Window Flashing to learn more. Available at:
<https://go.siga.swiss/ultimate-guide-to-window-flashing/>

PART 5 Construction Details

5.3 AIRTIGHT DETAILS AND SUBSTRATE TRANSITIONS

Maintain air barrier system continuity at wall, ceiling, floor and foundation intersections.

5.3.1 Substrate transitions

Ⓐ Transition to wood (CLT shown)

- Bond the perpendicular inside corner connection with split-backed Rissan 100
- Pre-fold the tape along the split and bond one surface at a time
- Bond without tension or tenting, and press on firmly



Ⓑ Transition to non-plastered masonry or concrete

- Apply an even coat of Dockskin 100 primer to the masonry substrate
- Let dry until Dockskin 100 appears transparent (10-30 min depending on temperature)
- Pre-fold Rissan 100 along the split backing and bond first to primed masonry
- Bond to Majrex 200, press on firmly

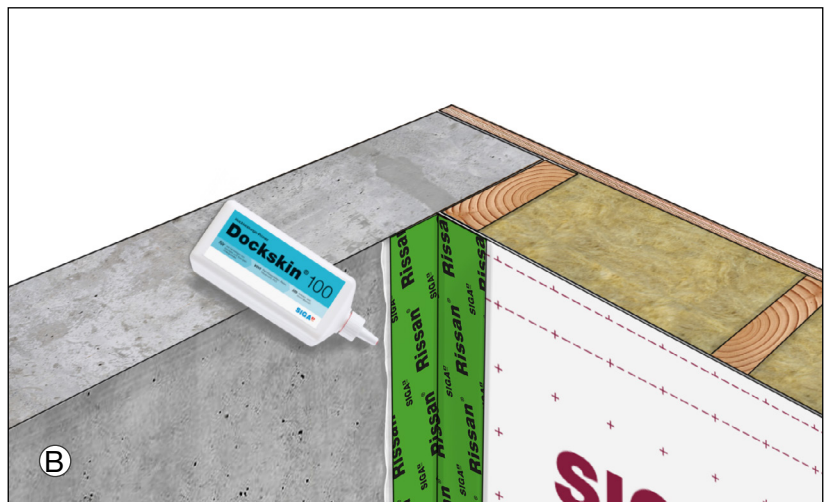

PART 5 Construction Details

5.3.2 Intersections with exterior wall

Ⓐ Floor to exterior wall

Pre-strip the wall top-plates during framing, with a vapor permeable exterior air barrier like Majvest 200

- Air-seal overlapping pieces of exterior air barrier with Wigluv
- Maintain at least 1¼" reveal when overlapping Majrex 200 with WRB
- Bond Majrex 200 to exterior air barrier using Rissan 60

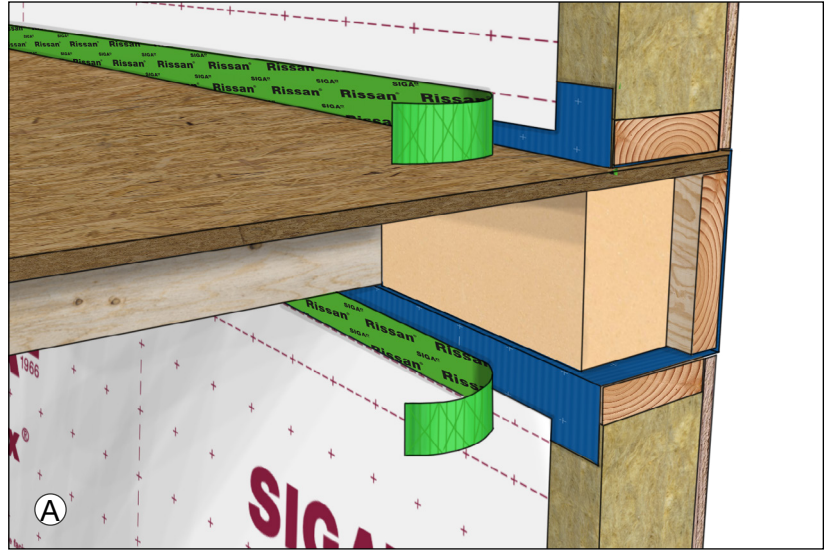

Ⓑ Foundation to exterior wall

- Install Majrex 200 with sufficient overlap to ensure tape adhesion
- Apply an even coat of Dockskin 100 primer to the masonry substrate
- Let dry until Dockskin 100 appears transparent (10-30 min depending on temperature)
- Pre-fold Rissan 100 along the split backing and bond first to primed masonry
- Bond to Majrex 200, press on firmly

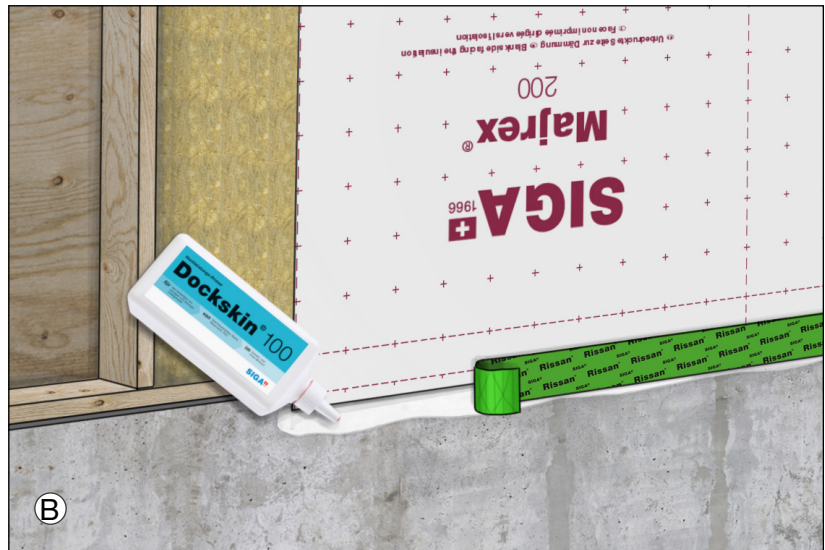

PART 5 Construction Details

5.3.3 Interior partition wall integration

Ⓐ Top floor/ceiling to partition

- Cut a 18" wide strip of Majrex 200 and connect joints with Rissan 60
- Pre-strip Majrex 200 on top of the partition wall rough framing before setting the ceiling / roof rafters
- Integrate pre-stripped Majrex 200 later to the main field membrane
- Tape overlaps using Rissan 60

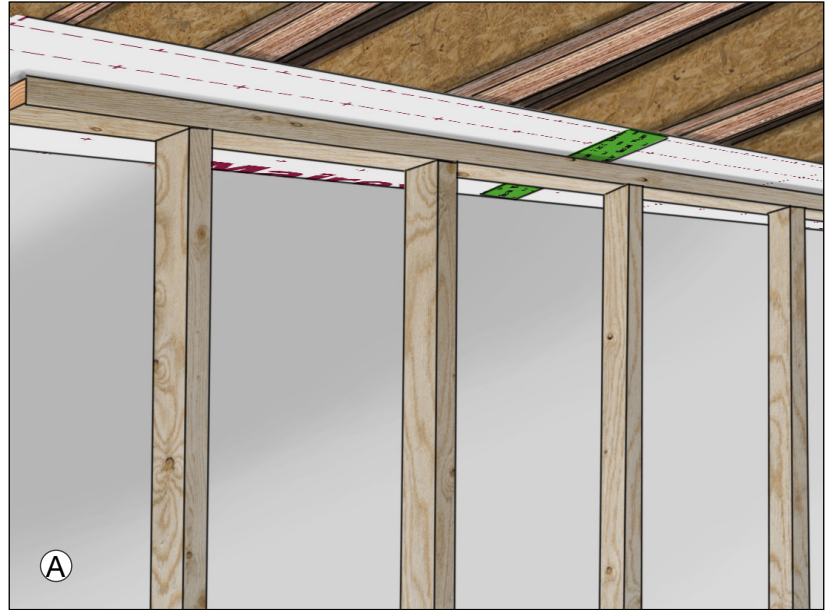

Ⓑ Exterior wall to partition

- Cut a 18" wide strip of Majrex 200 and connect joints with Rissan 60
- Pre-strip Majrex 200 at framing location of partition wall before setting the starting stud
- Connect Majrex 200 to airtight layer on top and bottom using Rissan 100
- Integrate pre-stripped Majrex 200 later to the main field membrane
- Tape overlaps using Rissan 60



SIGA Reliability

Product Performance and Limitations

SIGA Cover Inc. and SIGA Canada Inc. (SIGA) products have the properties set forth in the corresponding Technical Data Sheets (available at www.siga.swiss). However, SIGA excludes any liability for processing or use that does not comply with these guidelines, or:

- In case of unusual influences on the product, in particular of chemical or mechanical nature.
- If permanent mechanical strain (e.g. due to tensile and compression forces) has an impact on the seal.
- If multi-layered sheeting or paneling materials do not have sufficient cohesive strength.
- In case of open façade cladding with Majvest®200 or Majvest®500 SA.
- In case of air-sealing in areas with extraordinary moisture levels (e.g. sauna and swimming pool applications).
- When using Dockskin® 100, if the primed surface is not applied with Majvest® 500 SA, Wigluv®, Rissan® or Fentrim®.
- When the prerequisites for the secure laying of sheeting are not fulfilled. The substructure must be free of any protruding objects which could cause injury, such as screws etc.
- When the prerequisites for reliable sealing are not fulfilled. The substrate must be dry, structurally sound and free of any dirt, grease and debris. It must not be adhesive repellent. Before sealing clean the substrate and sheeting and perform an adhesion test on site.
- If substrates are too loose or not densified enough. Strengthen affected areas with the high-performance primer Dockskin® 100.
- If bonds are made under standing water.
- If creases or tension are not relieved. Cut and reseal in the affected areas.

In the IECC (2018) North America is divided into 8 different climate zones. Accordingly, different zone-related requirements are to be considered regarding the building envelope. For information about climate zones please refer to the International Energy Conservation Code. Consult your planner or building scientist to check whether your planned construction will meet the requirements of the respective climate zone.

Guidelines

These Guidelines can become invalid if new knowledge is acquired or new developments are made. The most up to date version is available at www.siga.swiss. SIGA assumes no liability for the accuracy, completeness or appropriateness of the drawings included in these Guidelines for a specific installation or purpose. Confirm project specific conditions with a local licensed design professional in order to assure compliance with all legal requirements. SIGA is not licensed to provide professional engineering or architectural services.

Technical Product Properties

SIGA high-performance adhesives are free of solvents, VOCs, high boilers, plasticizers, chlorine and formaldehyde. They cannot be removed after application. SIGA adhesives are pressure-activated and require firm installation pressure. Ageing resistant, durable adhesive power. Made without rubber, resins or solvent to prevent embrittlement.

Installation temperature (tapes and membranes): From -10°C / +14°F

Service temperature resistance (tapes): -40°C to +100°C / -40°F to +212°F

Service temperature resistance (membranes): -40°C to +80 °C / -40°F to +176°F

Store SIGA products cool and dry in original packaging. In addition, store Dockskin® 100 frost-free, and Majrex® 200, Majvest® 200, Majvest® 500 SA, Majvest® 700 SOB away from direct UV exposure. For Dockskin® 100, observe the use-by date.

10-Year Limited Warranty

For complete warranty details consult your local SIGA application advisor or consult the SIGA Limited Warranty Document available at www.siga.swiss.

© Developed and produced by SIGA Cover Inc. and by SIGA Canada Inc. All rights reserved

Product Information

Majrex® 200

The directional smart vapor control layer for roof, wall and ceiling structures



Modified PE/PA reinforced with PET fibres • Thickness 12 mils

- ✓ **Hygrobrid® technology**
increased safety in every construction
- ✓ **dimensionally stable**
can be laid quickly and without wrinkles
- ✓ **printed cutting and laying aid**
time saving

Product specifications

	Majrex 200
ARTICLE NO.	8310-150050
PALLET	30 rolls
WIDTH	1.5 m / 4.9'
LENGTH	50 m / 164'
WEIGHT/ROLL	13.5 kg / 29.8 lbs

Twinet®

Double-sided tape for the pre-installation of vapour control layers on hard substrates



Twinet is not suitable for permanent load-bearing applications • After installation, the vapour control layer must be additionally fastened, e.g. using jack rafters or counter battens

- ✓ **extremely adhesive on both sides**
quick, safe installation without stapler
- ✓ **protective coating prevents soiling**
simple to apply up to the end
- ✓ **tearproof backing strip**
saves time

Product specifications

	Twinet
ARTICLE NO.	6610-2050
BOX	10 rolls
WIDTH	20 mm / .79"
LENGTH	50 m / 164'

Rissan® 60

Single-sided high performance tape for air-sealing penetrations and overlaps of flexible sheet membranes and panelized materials



- ✓ extremely strong adhesion
reliable, long-term building value
- ✓ smooth carrier material
clings tightly around pipes and cables
- ✓ elastic
keeps joints sealed despite structural movements

Product specifications

	Rissan 60
ARTICLE NO.	2510-6025
BOX	10 rolls
WIDTH	60 mm / 2.4"
LENGTH	25 m / 82'

Special reinforced PE film • The bond must not be under standing water

Rissan® 100/150

Single-sided high performance tape for air-sealing penetrations and overlaps of flexible sheet membranes and panelized materials



- ✓ extremely strong adhesion
reliable, long-term building value
- ✓ split backing material
easy and accurate inside corner installation
- ✓ elastic
keeps joints sealed despite structural movements

Product specifications

	Rissan 100	Rissan 150
ARTICLE NO.	2510-10025	2510-15025
BOX	6 rolls	4 rolls
WIDTH	100 mm / 3.9"	150 mm / 5.9"
LENGTH	25 m / 82'	25 m / 82'

Special, reinforced PE film • The bond must not be under standing water

Fentrim® IS 20

Airtight high-performance tape for window and door frames, for indoor application



Semi-impermeable special PO film • 0.17 US perms • The bond must not be under standing water

- ✓ **high adhesive strength at high and low temperatures**
reliable, long-term building value
- ✓ **15mm pre-folded, without backing strip**
fastest bonding to window frames
- ✓ **bonding from -10°C/14°F**
fast and tight window installation all year-round

Product specifications

	Fentrim IS 20	Fentrim IS 20	Fentrim IS 20
ARTICLE NO.	9611-158025	9611-158525	9611-1513525
BOX	8 rolls	6 rolls	4 rolls
WIDTH	75mm / 2.9"	100mm / 3.9"	150mm / 5.9"
LENGTH	25 m / 82'	25 m / 82'	25 m / 82'

Dockskin® 100

High-performance primer for strengthening sandy and fibrous substrates



Water-based, solvent-free acrylate-copolymer dispersion • Shelf life: 18 months from the date of sale if unopened • Clean the brush immediately with water • Keep out of reach of children!

- ✓ **quick drying**
saves time
- ✓ **strong penetration**
extremely good adhesion on soft fibre boards, masonry and concrete
- ✓ **usable on cold substrates from -10°C/14°F**
solvent-free

Product specifications

	Dockskin 100
ARTICLE NO.	5930
BOX	8 bottles
WEIGHT / BOTTLE	1 kg / 2.2 lbs
COVERAGE RATE (AREA)	5 m ² / bottle 54 sq ft / bottle



Training

Gain know-how from our experts. SIGA offers job site training and educational workshops to help you achieve your air and weathertightness goals.



Job Site Training

Receive on-site application training and technical support to ensure your SIGA products are installed correctly and fit the unique details of your job.

Visit: https://www.siga.swiss/us_en/training/job-site-training

[Sign up for job site training](https://www.siga.swiss/us_en/training/job-site-training)



Educational workshops

Get your learn on by attending one of our air and weathertight education lessons. Workshops span from AIA and CPD-accredited lunch and learns to detailed application training.

Visit: https://www.siga.swiss/us_en/training/educational-workshops

[Sign up for an educational workshop](https://www.siga.swiss/us_en/training/educational-workshops)

Stick with us.

SIGA Cover Inc.
855-773-7442
americas@sigaswiss

[sigaswiss](https://www.sigaswiss.com)